



Parameter	Rating	Units
Breakdown Voltage - BV_{CEO}	350	V_P
Current Transfer Ratio - CTR	1000-8000	%

Features

- 3750V_{rms} Input/Output Isolation
- Machine Insertable, Wave Solderable
- Surface Mount Tape & Reel Version Available
- 350V_P Breakdown Voltage

Applications

- Telecom Switching
- Tip/Ring Circuits
- Hook Switch
- Modem Switching (Laptop, Notebook, Pocket Size)
- Loop Detect
- Ringing Detect
- Current Sensing

Description

The CPC1302 is a dual optocoupler with two identical, independent channels, each having a unidirectional input and a high-voltage Darlington output. Light output from the highly efficient GaAlAs infrared LED activates its associated, optically coupled silicon NPN photo-Darlington output transistor. The input LED and the output transistor are separated by a 3750V_{rms} isolation barrier.

With an LED current of only 1mA, a current transfer ratio of 1000% to 8000% is guaranteed at the collector of the 350V Darlington output transistor.

The CPC1302's low input current capability with high current transfer ratios, output voltage capability, and isolation barrier rating make it ideal for many applications such as telecom, industrial, and power control.

Approvals

- UL Recognized Component: File # E76270
- UL 1577 Double Protection
- CSA Certified Component:
Certificate # 156092 (LR43639)
- EN/IEC 60950-1 compliant

Ordering Information

Part Number	Description
CPC1302G	8-Pin DIP (50/Tube)
CPC1302GS	8-Pin Surface Mount (50/Tube)
CPC1302GSTR	8-Pin Surface Mount (1000/Reel)

Pin Configuration

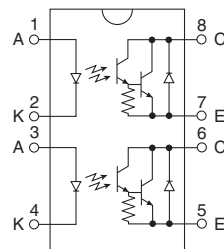

Absolute Maximum Ratings

Parameter	Ratings	Units
Breakdown Voltage, BV_{CEO}	350	V_P
Reverse Input Voltage	5	V
Input Control Current	50	mA
Peak (10ms)	1	A
Input Power Dissipation ¹ (Each)	150	mW
Phototransistor Power Dissipation ² (Each)	150	mW
Isolation Voltage, Input to Output	3750	V_{rms}
Operational Temperature	-40 to +85	$^{\circ}C$
Storage Temperature	-40 to +125	$^{\circ}C$

¹ Derate Linearly 1.33 mW/ $^{\circ}C$

² Derate Linearly 1.5 mW/ $^{\circ}C$

Electrical absolute maximum ratings are at 25 $^{\circ}C$

Electrical Characteristics

Parameters	Conditions	Symbol	Min	Typ	Max	Units
Output Characteristics @ 25$^{\circ}C$						
Phototransistor Breakdown Voltage	$I_{CEO}=100\mu A$	BV_{CEO}	350	-	-	V_P
Emitter-Collector Breakdown Voltage	$I_E=0.1mA$	BV_{ECO}	0.3	-	-	V
Phototransistor Output (Dark) Current	$V_{CEO}=200V, I_F=0mA$	I_{CEO}	-	-	100	nA
Saturation Voltage	$I_C=10mA, I_F=1mA$	$V_{CE(sat)}$	-	-	1	V
	$I_C=100mA, I_F=10mA$		-	-	1.2	V
Current Transfer Ratio	$I_F=1mA, V_{CE}=1V$	CTR	1000	5500	8000	%
Output Capacitance	$V_{CEO}=50V, f=1MHz$	C_{OUT}	-	13	-	pF
Input Characteristics @ 25$^{\circ}C$						
Input Control Current	$I_C=10mA, V_{CE}=1V$	I_F	-	0.07	1	mA
Input Voltage Drop	$I_F=5mA$	V_F	0.9	1.2	1.4	V
Input Reverse Current	$V_R=5V$	I_R	-	-	10	μA
Common Characteristics @ 25$^{\circ}C$						
Input to Output Capacitance	-	C_{IO}	-	3	-	pF

Switching Characteristics @ 25 $^{\circ}C$

Characteristic	Symbol	Test Condition	Typ	Units
Rise Time	t_R	$V_{CC}=10V$ $I_F=10mA$ $R_L=100\Omega$	40	μS
Fall Time	t_F		5	
Turn-On Time	t_{ON}		5	
Storage Time	t_S		20	
Turn-Off Time	t_{OFF}		60	
Turn-On Time	t_{ON}	$V_{CC}=10V$	1	
Storage Time	t_S	$I_F=16mA$	40	
Turn-Off Time	t_{OFF}	$R_L=180\Omega$	80	

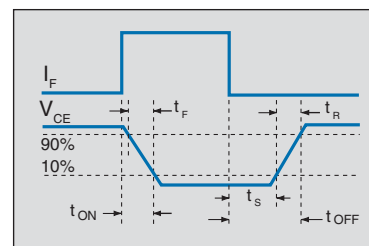
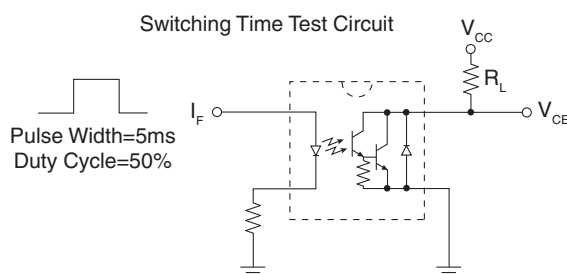

PERFORMANCE DATA *

**CPC1302
LED Current (I_F) vs.
LED Forward Voltage (V_F)
($T_A=25^\circ\text{C}$)**

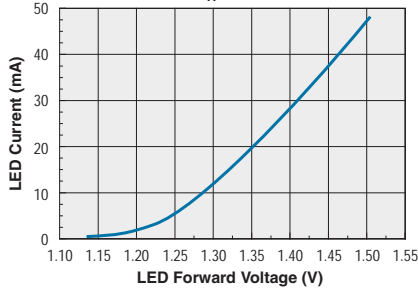

**CPC1302
LED Current (I_F) vs.
LED Forward Voltage (V_F)
($T_A=25^\circ\text{C}$)**

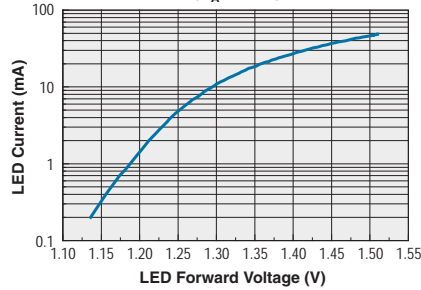

**CPC1302
LED Forward Voltage vs. Temperature**

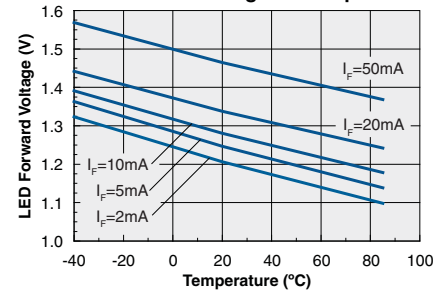

**CPC1302
CTR vs. LED Current (I_F)
($T_A = 25^\circ\text{C}$)**

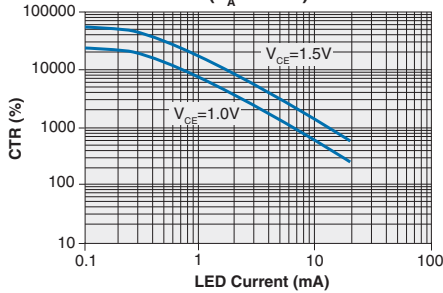

**CPC1302
Collector Current vs. LED Current (I_F)
($T_A = 25^\circ\text{C}$)**

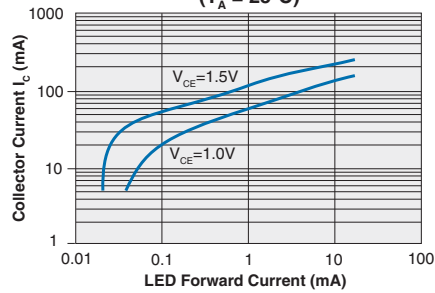

**CPC1302
Collector Current vs. Temperature
($V_{CE} = 1.2\text{V}$)**

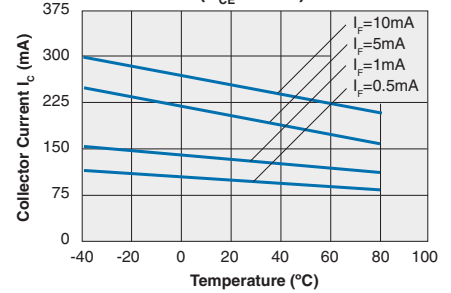

**CPC1302
Collector Current vs.
Collector-Emitter Voltage
($T_A=25^\circ\text{C}$)**

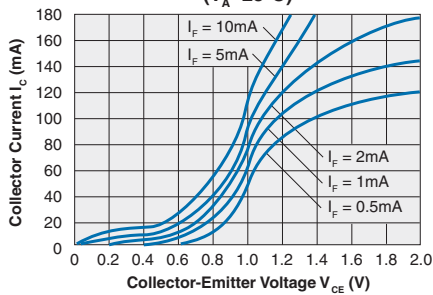

**CPC1302
Leakage vs. Temperature
($V_{CE0}=350\text{V}$)**

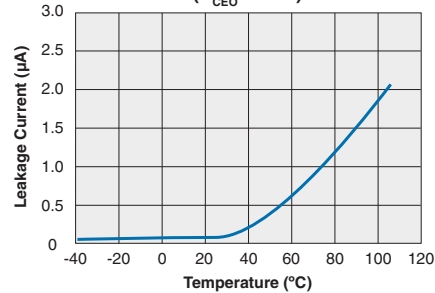

**CPC1302
Breakdown Voltage vs. Temperature**

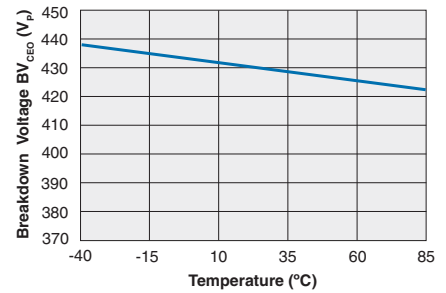

**CPC1302
Switching Time vs. Load Resistance
($T_A=25^\circ\text{C}$)**

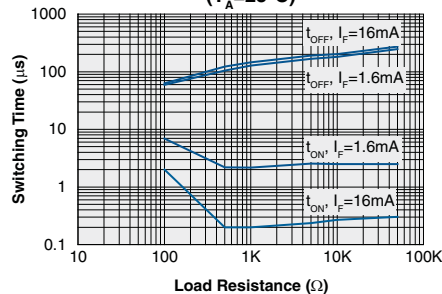

*The Performance data shown in the graphs above is typical of device performance. For guaranteed parameters not indicated in the written specifications, please contact our application department.

Manufacturing Information

Soldering

For proper assembly, the component must be processed in accordance with the current revision of IPC/JEDEC standard J-STD-020. Failure to follow the recommended guidelines may cause permanent damage to the device resulting in impaired performance and/or a reduced lifetime expectancy.

Washing

Clare does not recommend ultrasonic cleaning or the use of chlorinated solvents.



MECHANICAL DIMENSIONS

8-Pin DIP Through-Hole Package

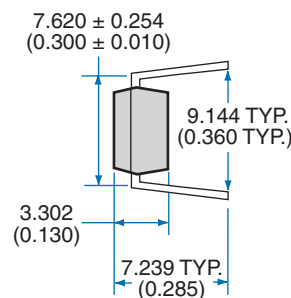
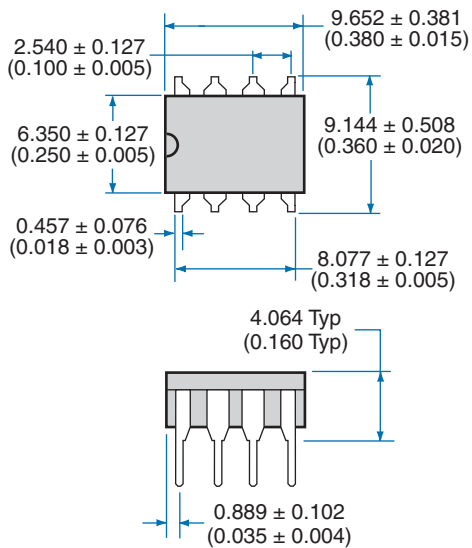

PC Board Pattern

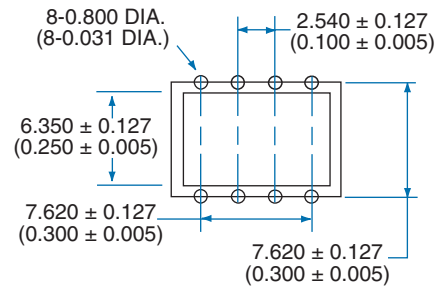

Dimensions
mm
(inches)

8-Pin Surface Mount Package

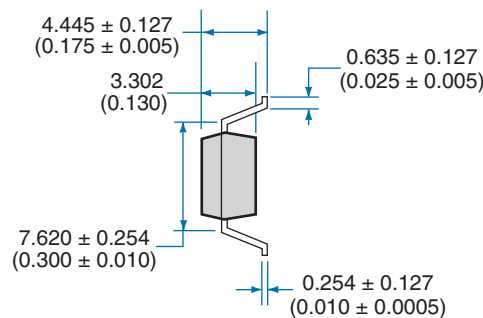
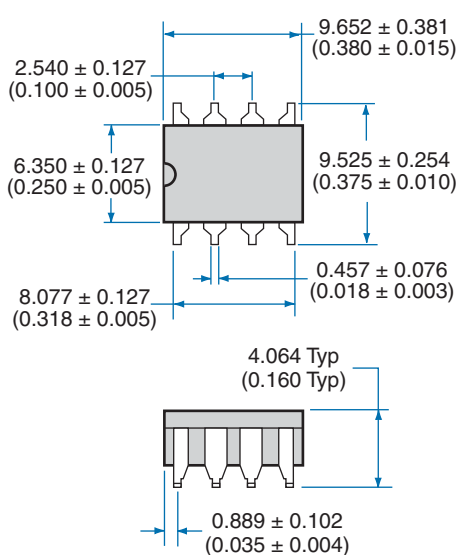

Recommended PCB Land Pattern

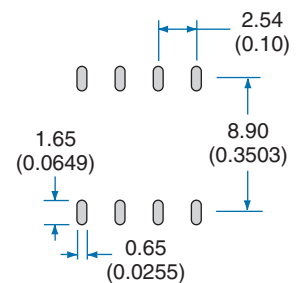

Dimensions
mm
(inches)

MECHANICAL DIMENSIONS

Tape and Reel Packaging for 8-Pin Surface Mount Package

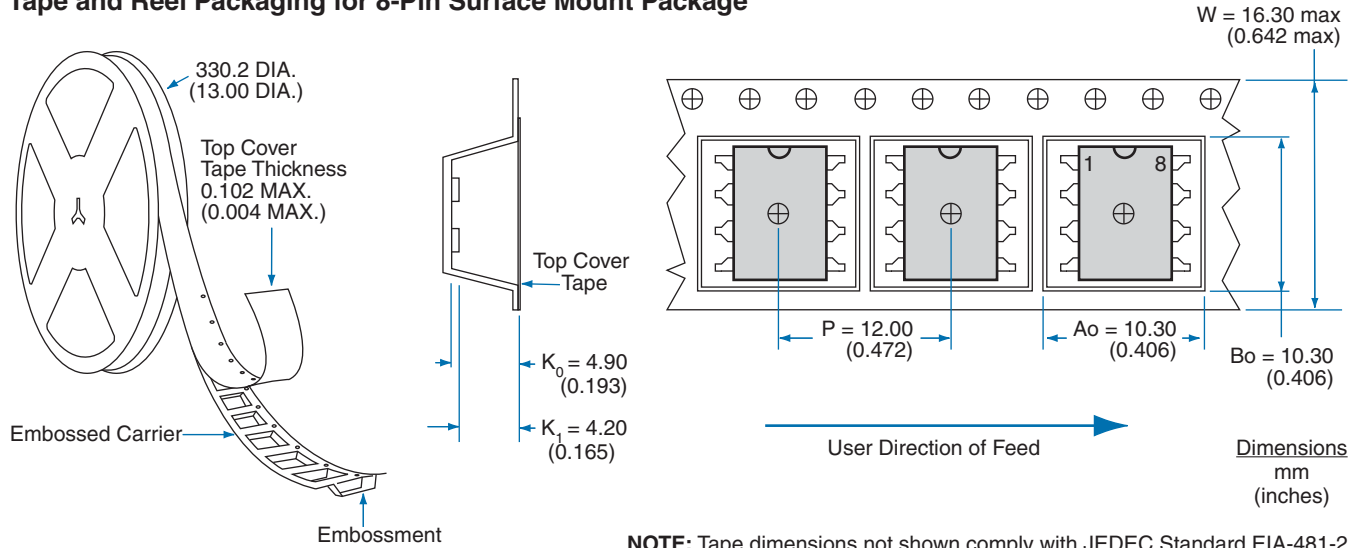

NOTE: Tape dimensions not shown comply with JEDEC Standard EIA-481-2

For additional information please visit our website at: www.clare.com

Clare, Inc. makes no representations or warranties with respect to the accuracy or completeness of the contents of this publication and reserves the right to make changes to specifications and product descriptions at any time without notice. Neither circuit patent licenses nor indemnity are expressed or implied. Except as set forth in Clare's Standard Terms and Conditions of Sale, Clare, Inc. assumes no liability whatsoever, and disclaims any express or implied warranty, relating to its products including, but not limited to, the implied warranty of merchantability, fitness for a particular purpose, or infringement of any intellectual property right.

The products described in this document are not designed, intended, authorized or warranted for use as components in systems intended for surgical implant into the body, or in other applications intended to support or sustain life, or where malfunction of Clare's product may result in direct physical harm, injury, or death to a person or severe property or environmental damage. Clare, Inc. reserves the right to discontinue or make changes to its products at any time without notice.